

Model # MHVSS
Vertical Sausage Stuffer
INSTRUCTION MANUAL

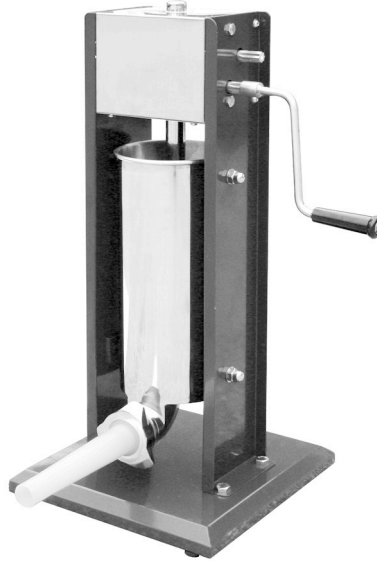

READ ALL INSTRUCTIONS AND WARNINGS BEFORE USING THIS PRODUCT.

This manual provides important information on proper operation & maintenance. Every effort has been made to ensure the accuracy of this manual. These instructions are not meant to cover every possible condition and situation that may occur. We reserve the right to change this product at any time without prior notice.

**IF THERE IS ANY QUESTION ABOUT A CONDITION BEING SAFE OR UNSAFE,
DO NOT OPERATE THIS PRODUCT!**

DO NOT RETURN THIS PRODUCT TO THE RETAILER - CONTACT CUSTOMER SERVICE.

If you experience a problem, have questions or need parts for this product, call Customer Service at 1-888-287-6981, Monday-Friday, 8 AM - 4 PM Central Time. A copy of the sales receipt is required.

FOR CONSUMER USE ONLY – NOT FOR PROFESSIONAL USE.

KEEP THIS MANUAL, SALES RECEIPT & APPLICABLE WARRANTY FOR FUTURE REFERENCE.

Model MHVSS Vertical Sausage Stuffer

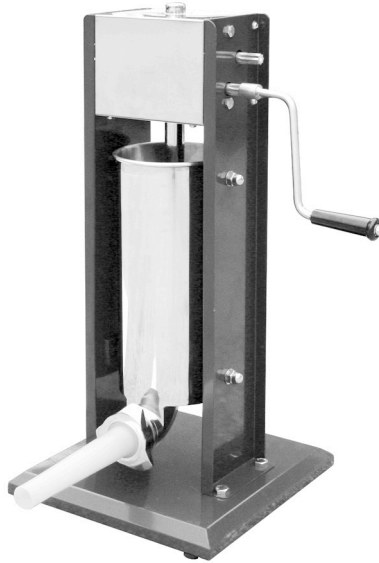

FEATURES:

- Heavy-Duty, 2-Speed Hand-Cranked Piston
- Vertical Design Handles Large Quantities Of Sausage Mix
- Three Sausage Funnels (1", 3/4", and 1/2")
- Stainless Steel Canister Tilts For Easily Clean Up
- 11 Lb. Capacity

FOR CONSUMER USE ONLY – NOT FOR PROFESSIONAL USE

TABLE OF CONTENTS

RECOGNIZE SAFETY SYMBOLS, WORDS AND LABELS	4
SERVICE.....	5
PACKAGE CONTENTS	5
COMPONENTS.....	6
OPERATION	7
INSTALLING OR REPLACING FUNNELS	7
MAINTENANCE	8
ACCESSORIES	8

RECOGNIZE SAFETY SYMBOLS, WORDS AND LABELS

What You Need to Know About Safety Instructions

Warning and Important Safety Instructions appearing in this manual are not meant to cover all possible conditions and situations that may occur. Common sense, caution and care must be exercised when operating or cleaning tools and equipment.

Always contact your dealer, distributor, service agent or manufacturer about problems or conditions you do not understand.



WARNING indicates a potentially hazardous situation which, if not avoided, could result in death or serious injury.



CAUTION indicates a potentially hazardous situation which, if not avoided, may result in minor or moderate injury.



CAUTION used without the safety alert symbol indicates a potentially hazardous situation which, if not avoided, may result in property damage.



NOTE provides additional information that is useful for proper use and maintenance for this tool. If a NOTE is indicated make sure it is fully understood.

IMPORTANT SAFETY INSTRUCTIONS

WARNING

Keep your work area clean and well lit. Cluttered work benches and dark work areas may cause accidents or injury.

CAUTION

Do not force. Use the correct sausage stuffer for your application. The correct sausage stuffer will do the job better and safer at the rate for which it is designed.

Store idle items out of reach of children and other untrained persons. Kitchen items are dangerous in the hands of untrained users.

SERVICE

Service must be performed only by qualified repair personnel. Service or maintenance by unqualified personnel could result in a risk of injury.

When servicing, use only identical replacement parts. Follow instructions in the Maintenance section of this manual. Use of unauthorized parts or failure to follow Maintenance Instructions may cause personal injury or void warranty.

SAVE THESE INSTRUCTIONS FOR FUTURE REFERENCE.

This manual contains important information regarding safety, operation, maintenance and storage of this product. Before use, read carefully and understand all warnings, cautions, instructions and labels.

PACKAGE CONTENTS

- Vertical Sausage Stuffer
- Three Sausage Funnels

COMPONENTS

Observe the locations and functions of the various components and controls of this tool.

- 1) Sausage Stuffer Funnel
- 2) Screw Ring
- 3) Stainless Steel Food Hopper
- 4) Rack
- 5) High Speed Gear
- 6) Low Speed Gear
- 7) Handle
- 8) Base
- 9) Piston (not shown, see page 7)

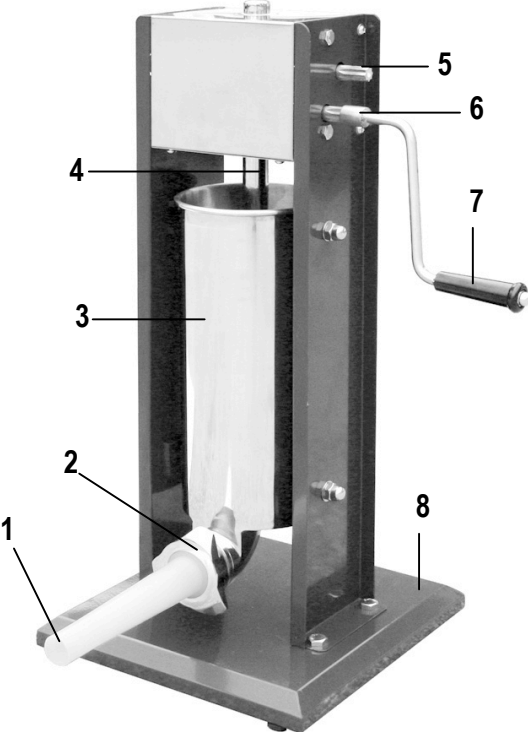

OPERATION

NOTE

Unpack product from package and review contents. Keep all packaging until product has been reviewed.

Before and after use, wash all parts with warm soapy water.

1. The Food Hopper (A, Figure 1) pivots from the bottom to the rear of the stuffer to allow you to fill it with the mixture of your choice.
2. Once filled, restore the Food Hopper to its upright position and snap it in place. NOTE: The Food Hopper can only pivot if the Rack (B) is raised completely clear of the inside of the cylinder. If lowered to the horizontal position, the Food Hopper can be removed for cleaning or servicing.
3. Use the High Speed (C) Gear for quick reverse. Use the Low Speed (D) Gear (Figure 2) to force the mixture down the cylinder into the sausage stuffer of your choice (E, Figure 2).
4. When finished stuffing sausages, clean all parts with warm, soapy water and store under cover.

(H shows the PISTON)

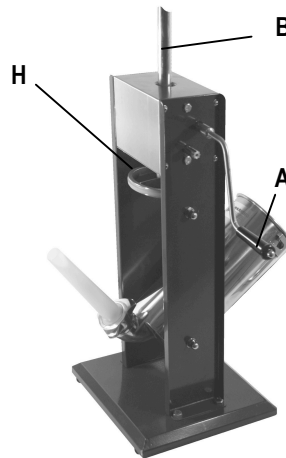

Figure 1

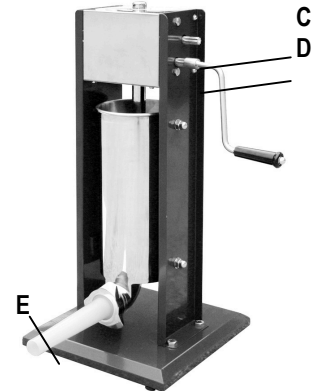

Figure 2

INSTALLING OR REPLACING THE FUNNEL ATTACHMENT

This Model MHVSS Vertical Sausage Stuffer includes three different sausage-making funnels. To install or replace a funnel:

1. Unscrew the Screw Ring from the bottom of the food hopper. (F, Figure 3)
2. Insert desired funnel into Screw Ring (G), then fasten both to the food hopper.

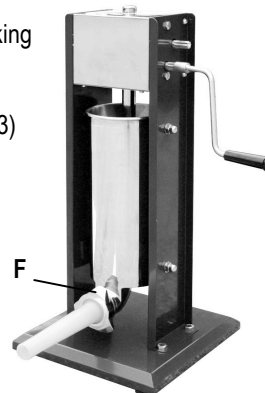
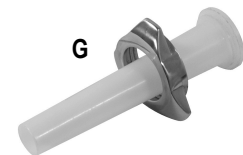

Figure 3



MAINTENANCE

CAUTION

Applying excessive force can damage the piston and the Food Hopper, decrease the life and increase the wear on this product.

Some chemicals can damage the product. Do not use harsh chemicals such as gasoline, carbon tetrachloride, paint thinner, etc. to clean this product. Use warm soapy water only.

CAUTION

A qualified repair technician must perform any service or repair. Service or maintenance performed by unqualified personnel could result in injury. Use only identical replacement parts. Use of unauthorized parts or failure to follow maintenance instructions may create a risk of electric shock or injury.

Before using this Model MHVSS Vertical Sausage Stuffer for the first time, wash all its parts with warm, soapy water and do so after every use. Lubricate all moving parts. Check nuts and screws to make sure they are tight before and after use. Store under cover.

ACCESSORIES

Use only accessories that are recommended by the manufacturer for your model. Accessories that may be suitable for one tool may become hazardous when used on another tool.