

# SSBTB







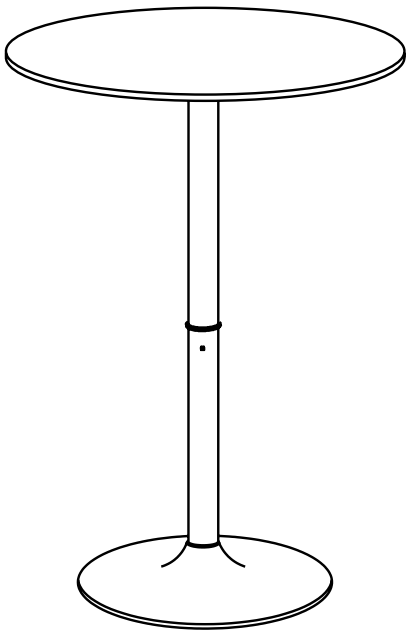

## Stainless Steel Bar Table

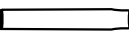
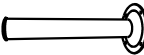
IF THERE IS ANY QUESTION ABOUT THIS PRODUCT BEING SAFE OR UNSAFE, DO NOT USE!

DO NOT RETURN THIS PRODUCT TO THE RETAILER - CONTACT CUSTOMER SERVICE FIRST. If you experience a problem, have questions or need parts for this product, visit our website <http://www.amerihomebrand.com> or call Customer Service at 1-888-287-6981, Monday-Friday, 8 AM - 4 PM Central Time, or email: [info@amerihomebrand.com](mailto:info@amerihomebrand.com). A copy of the receipt is required. KEEP THIS MANUAL, SALES RECEIPT & APPLICABLE WARRANTY FOR FUTURE REFERENCE.

**Max Weight Capacity 330 Lb**



(1)	 tabletop	1pc
(2)	 tube 1	1pc
(3)	 tube 2	1pc
(4)	 base	1pc
(5)	 screw M6X14MM	4pcs
(6)	 washer M6X13X1MM	4pcs
(7)	 screw M8X45MM	1pc
(8)	 screw M6X6MM	2pcs
(9)	 washer	1pc
(10)	 hex wrench M3	1pc
(11)	 hex wrench M5	1pc

1

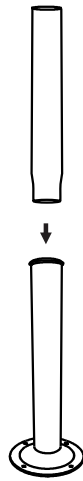

Locate tubes (#2) & (#3).

2

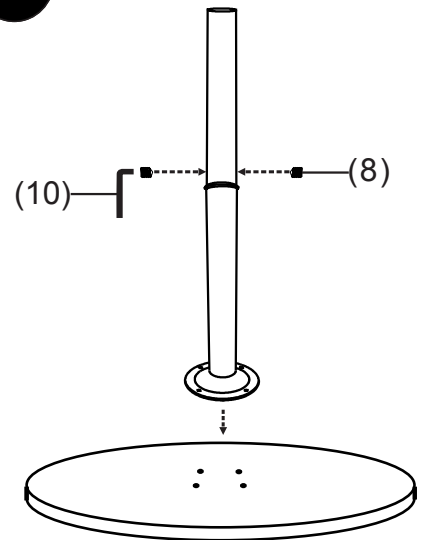

Use M3 hex wrench to attach tubes to tabletop using screw (#8).

3

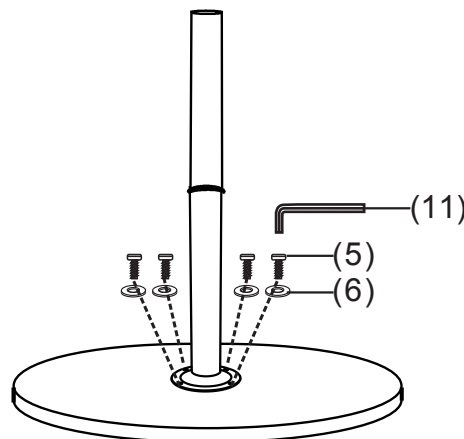

Use M5 hex wrench and attach the tabletop with screws (#5) and washers (#6).

4

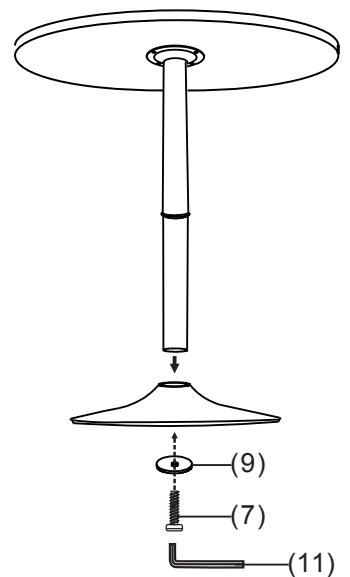

Use M5 hex wrench to attach base with screw (#7) and washer (#9). Make sure all screws are fully secure when assembly is complete.