

BG8DL

8 Inch Bench Grinder

Assembly & Operating Instructions



READ ALL INSTRUCTIONS AND WARNINGS BEFORE USING THIS PRODUCT.

SAVE THESE INSTRUCTIONS FOR FUTURE REFERENCE.

This manual provides important information on proper operation and maintenance. Every effort has been made to ensure the accuracy of this manual. We reserve the right to change this product at any time without prior notice.

STOP! DO NOT RETURN THIS PRODUCT TO THE RETAILER.

Questions? Problems? CONTACT CUSTOMER SERVICE.

If you experience a problem or need parts for this product, visit our website <http://www.buffalotools.com> or call our customer help line at **1-888-287-6981, Monday-Friday, 8 AM - 4 PM Central Time**. A copy of the sales receipt is required.

TABLE OF CONTENTS

RECOGNIZE SAFETY SYMBOLS, WORDS AND LABELS.....	2
SERVICE	6
SPECIFIC SAFETY RULES AND/OR SYMBOLS	6
PACKAGE CONTENTS	7
COMPONENTS	7
ASSEMBLY	8
OPERATION.....	9
MAINTENANCE	9
ACCESSORIES	9
PARTS DIAGRAM.....	10
PARTS LIST.....	11

RECOGNIZE SAFETY SYMBOLS, WORDS AND LABELS

What You Need to Know About Safety Instructions

Warning and Important Safety Instructions appearing in this manual are not meant to cover all possible conditions and situations that may occur. Common sense, caution and care must be exercised when assembling or using this product.

Always contact your dealer, distributor, service agent or manufacturer about problems or conditions you do not understand.



WARNING

This is a safety alert symbol. It is used to alert you to potential personal injury hazards. Obey all safety messages that follow this symbol to avoid possible injury or death.

CAUTION

This is a safety alert symbol. It is used to alert you to potential personal injury hazards. Obey all safety messages that follow this symbol to avoid possible injury or death.

GENERAL PRODUCT SPECIFICATIONS



FEATURES:

- 241.5 Watts Max
- 115V / 60 Hz
- 1/3 HP
- Speed 3560 No Load RPM / 2.1 AMP
- 5/8" Arbor
- Wheel Size - 8 inch x 3 /4 inch

SPECIFICATIONS

KEEP THIS MANUAL, SALES RECEIPT & APPLICABLE WARRANTY FOR FUTURE REFERENCE. READ ALL INSTRUCTIONS AND WARNINGS BEFORE USING THIS PRODUCT. When unpacking, check to make sure all parts listed are included. If any parts are missing or broken, please call Customer Service at 1-888-287-6981.

FOR CONSUMER USE ONLY – NOT FOR PROFESSIONAL USE

IMPORTANT SAFETY RULES

COMMON SENSE AND CAUTION ARE FACTORS WHICH CANNOT BE BUILT INTO ANY PRODUCT. THESE FACTORS MUST BE SUPPLIED BY THE OPERATOR.

WARNING

Keep your work area clean and well lit. Cluttered work benches and dark work areas may cause accidents or injury.

Do not operate power tools in explosive areas, such as in the presence of flammable liquids, gases or dust. Power tools create sparks which may ignite the dust or fumes.

Keep bystanders, children and visitors away while operating a power tool. Distractions can cause you to lose control.

WARNING

Double insulated tools are equipped with a polarized plug (one blade is wider than the other.) This plug will fit in a polarized outlet only one way. If the plug does not fit fully in the outlet, reverse the plug. If it still does not fit, contact a qualified electrician to install a polarized outlet. Do not change the plug in any way. Double insulation eliminates the need for the three wire grounded power cord and grounded power supply system.

Avoid body contact with grounded surfaces such as pipes, radiators, ranges and refrigerators. There is an increased risk of electric shock if your body is grounded.

Do not abuse the cord. Never use the cord to carry the tool or pull the plug from an outlet. Keep the cord away from heat, oil, sharp edges, or moving parts. Replace damaged cords immediately. Damaged cords increase the risk of electric shock.

When operating the tool outside, use an outdoor extension cord marked “WA” or “W.” These cords are rated for outdoor use and reduce the risk of electric shock. Make sure the extension cord being used is in good condition. If there are any cuts or nicks (no matter how deep) in the insulation, DO NOT use that cord. Also, make sure the extension cord is heavy enough to carry the current needed. DO NOT use small "around-the-house" lamp extension cords. These cords can easily overheat and/or catch fire when used with power tools.

CAUTION

Do not force tool. Use the correct tool for your application. The correct tool will do the job better and safer at the rate for which it is designed.

Do not use the tool if the power switch does not turn it “ON” or “OFF”. Any tool that cannot be controlled with the switch is dangerous and must be repaired.

Disconnect the power cord plug from the power source before making any adjustments, changing accessories or storing the tool. Such preventive safety measures reduce the risk of starting the tool accidentally.

Store idle tools out of reach of children and other untrained persons. Tools are dangerous in the hands of untrained users.

DANGER

People with pacemakers or other electronic devices should consult with a physician before operating this product. Interruption or failure of the pacemaker could occur when electrical equipment is operated within close proximity of electrical devices.

⚠ WARNING

Wash hands after handling the power cord. Touching the power cord could expose you to lead, which is known in the State of California to cause cancer, birth defects and other reproductive harm.

⚠ WARNING

All work areas should be clean and well lit. Accidents are more likely to occur in poorly lit and cluttered areas.

⚠ WARNING

Keep children, and other distractions at a distance while operating power tools.

⚠ WARNING

Keep the power cord in good condition, and replace damaged cords immediately. Do not use the cord to pull the plug from the outlet. Keep the cord away from materials and surfaces that could damage cords. The risk of electric shock increases when the power cord is damaged.

⚠ WARNING

Always use the appropriate extension cord, making sure it is rated for use with power tools. Always be sure the extension cords are in good condition, free of cuts or nicks in the insulation. If using the power tool in an outside area with an extension cord, make sure the cord is rated for outdoor use.

⚠ WARNING

Do not make contact with a grounded surface while using this power tool. Contact with surfaces like pipes, radiators or major appliances increases your risk of electric shock.

⚠ WARNING

Use common sense while operating this power tool.

Do not use this tool if you are:

- Feeling tired or are under the influence of alcohol or drugs.
- Wearing loose clothing or jewelry. Keep long hair pulled back and away from moving parts.
- Overreaching or have improper footing. Handling the tool in this way could cause serious injury.

When using this power tool always:

- Wear the proper safety equipment, such as safety goggles, dust masks, non-skid shoes, etc.
- Check to be sure all adjusting keys or wrenches have been removed before starting the power tool.
- Check to be sure the power switch is in the "OFF" position before plugging the power tool into an electrical outlet.

⚠ CAUTION

Follow these steps to maintain safe working conditions and good working condition of power tools.

Improper care can result in electric shock or serious injury.

- **Secure and support the work piece using clamps. Do not use your hands to hold the piece in place.**
- **Use the correct tool for the job.** Using the correct tool is safer and faster.
- **Make sure the power switch is in good working order.** If the power switch no longer turns the tool "ON" or "OFF", discontinue use, and have the tool replaced or repaired.
- **Remove the power cord from the power source before storage, changing accessories, or moving the tool.**
- **Keep out of reach of children,** or any untrained person. Store tools in a safe and dry place.
- **Keep tools clean, and cutting tools sharp.** Maintaining tools with proper care will increase the life of the power tool, and reduce the risk of injury.
- **Check to be sure all moving parts are free from binding and are properly aligned.**
- Use only accessories that are recommended by the manufacturer for your tool model.

⚠ WARNING

Safety glasses and ear protection must be worn during operation.

SERVICE

Tool service must be performed only by qualified repair personnel. Service or maintenance by unqualified personnel could result in a risk of injury.

When servicing a tool, use only identical replacement parts and follow instructions in the manual. Use of unauthorized parts or failure to follow Maintenance Instructions may create a risk of shock or injury.

SAVE THESE INSTRUCTIONS FOR FUTURE REFERENCE.

This manual contains important information regarding safety, operation, maintenance and storage of this product. Before use, read carefully and understand all warnings, cautions, instructions and labels. Failure to do so could result in serious personal injury, property damage or even death.

IMPORTANT SAFETY INSTRUCTIONS

WARNING





Before using this tool, you need to become familiar with its operation. If you are unsure about the operation of the tool, or have any questions about its proper use, call the Customer Service Department at 1-888-287-6981. Follow these instructions for safe handling of the tool:

- **Always secure and support the work piece using clamps. Do not use your hands to hold the piece in place.**
- **Be sure your work area is clean and secure before turning the power switch into the “ON” position.** Be sure the area is free from all foreign material, nails, staples, or any other material.
- **Turn the tool “OFF” and unplug from the power source before making any changes or adjustments to the saw blade.**
- **Do not use solvents containing carbon tetrachloride, ammonia or acetone to clean the saw.** Never use gasoline, paint thinner, or other caustic chemicals that can damage the plastic parts of the tool.
- **Always use the appropriate safety gear when operating this saw.** Including but not limited to, goggles, dust mask or respirator. Always work in a well-ventilated area to reduce your exposure to harmful chemicals and dust particles.
- **Keep hands away from the cutting area.**
- **Do not reach under the work piece.**

SPECIFIC SAFETY RULES AND/OR SYMBOLS

SYMBOLS

The following symbols may be used on your tool. Be familiar with and learn the symbols to operate the tool safely.

Symbol	Name	Description
V	Volts	Voltage (Potential)
A	Amperes	Current
Hz	Hertz	Frequency (Cycles per Second)
W	Watt	Power
Kg	Kilograms	Weight
	Alternating Current	Type of Current
	Direct Current	Type of Current
	Alternating or Direct Current	Type of Current
	Earthing Terminal	Grounding Terminal
	Class II Construction	Denotes Double Insulation
min	Minutes	Time
s	Seconds	Time
φ	Diameter	Size of Drill Bits, Grinding Wheels, etc.
n_0	No Load Speed	No-load Rotational Speed
.../min	Revolutions per Minute	Revolutions, Surface Speed, Strokes, etc. per Minute
1,2,3...	Ring Selector Settings	Speed, Torque or Position Settings

PACKAGE CONTENTS

- Bench Grinder
- 2 Grinding Wheels (One Course and One Medium)
- 2 Tool Rests
- 2 Eye Shields

COMPONENTS

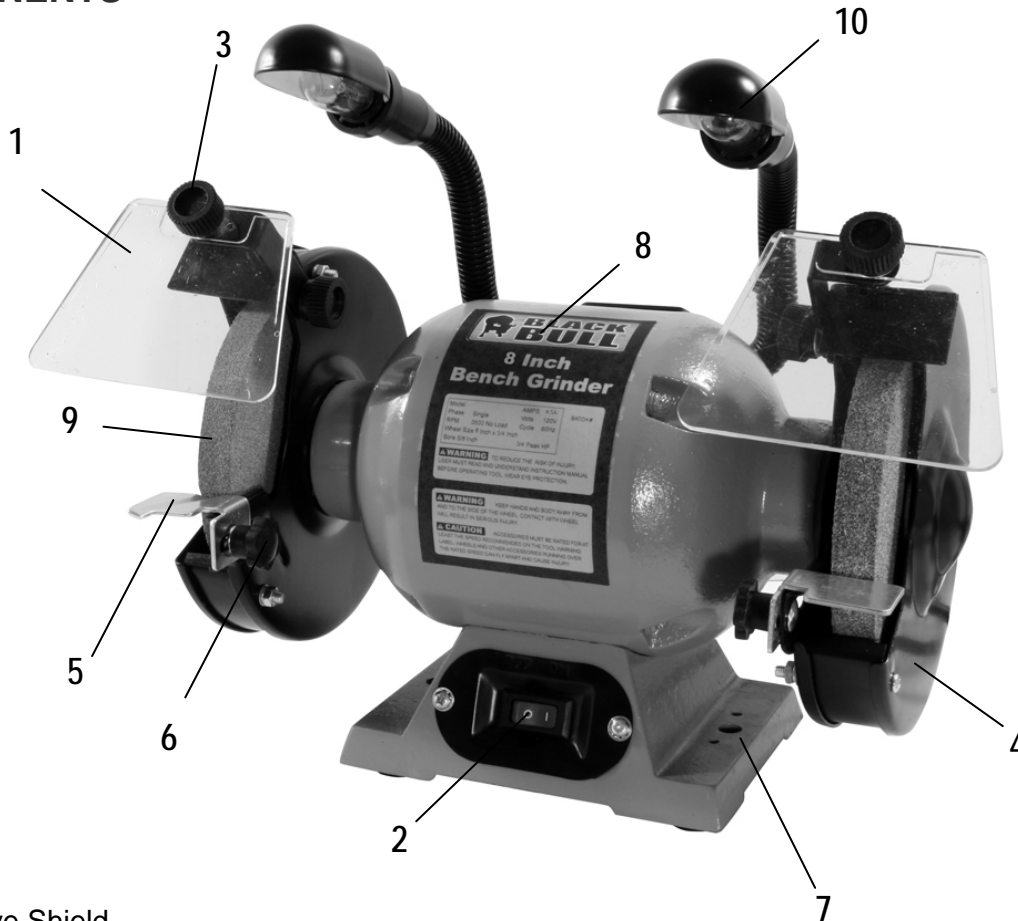

- 1) Eye Shield
- 2) Power Button
- 3) Eye Shield Adjustment
- 4) Wheel Guard
- 5) Tool Rest
- 6) Tool Rest Adjustment
- 7) Mounting Holes
- 8) Bench Grinder
- 9) Grinding Wheel
- 10) Adjustable Lights

ASSEMBLY

INSTALLING/REPLACING GRINDING WHEELS, TOOL RESTS, EYESHIELDS

⚠ WARNING

Always use the proper grinding wheels for the bench grinder. Grinding wheels that do not properly fit will cause loss of control.

⚠ WARNING

Before installing or replacing the grinding wheels, make sure the power cord is unplugged. Failure to do so could result in serious injury or electric shock.

NOTE

Unpack product from package and review contents. Keep all packaging until product has been reviewed.

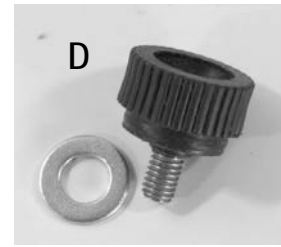
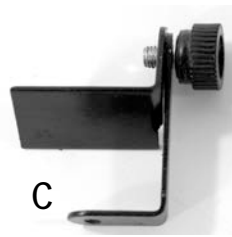
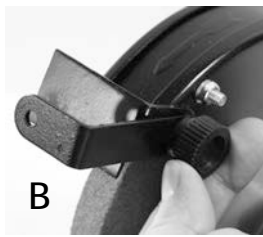
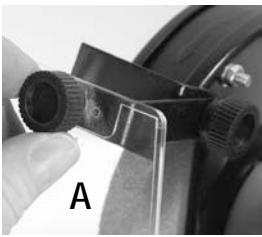

Double check that the bench grinder is off and unplugged from a power source before attempting to install or remove the grinding wheel(s). Follow the illustrations to remove/install the Eye Shield and attach/remove it from the Bench Grinder. Be certain to use the bolts and washers as indicated.

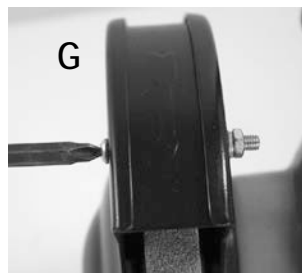
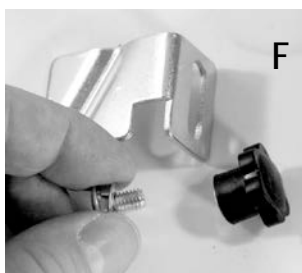
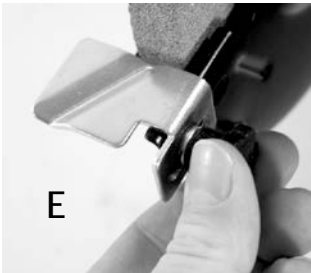

There is a left and right tool rest. When in actual use, the tool rests should be adjusted to within 1/8" (3.2mm) of the grinding wheel or other accessory being used. Follow the illustrations to remove/install the tool rest. The Grinding Wheel is accessed by removing the Eye Shield and Tool Rest and the Wheel Guard.

While the Grinding Wheel is removed, clear any debris from the inner flange. Then install the new Grinding Wheel, the arbor screw, washer and outer flange.

Check that the Grinding Wheel rotates easily and fully, and is securely held in place after replacing the arbor screw and outer flange.



Your Bench Grinder may include adjustable lights. Lights can provide visual aid when using the Bench Grinder (Figure I)

Note: You may choose to fasten the Bench Grinder to a secure base. The base includes pre-drilled holes to attach 5/16" bolts to a secure surface.

OPERATION

⚠ CAUTION

Wear safety eyewear and dust filters or respirators while using this tool.

⚠ WARNING

Keep hands and fingers away from the rotating Grinding Wheel while it is in operation. Your fingers can get stuck inside the rotating wheel and cause serious injury to the user.

Keep a steady pressure on the workpiece. Keep it moving at an even pace for smooth grinding. Press too hard and it will overheat the motor. Note the original bevel angle on the item to be sharpened, and try to maintain the shape. The grinding wheel should rotate into the object being sharpened. Keep a tray filled with water and dip your work into it regularly to prevent overheating.

MAINTENANCE

⚠ WARNING

Disconnect the power supply before cleaning. Wear safety eyewear before cleaning. Used compressed dry air to blow off dust and debris. Use a soft bristle brush if compressed air is not available.

CAUTION

Applying excessive force to the tool can overload the motor, decrease the life and increase the wear on the tool.

CAUTION

Some chemicals can damage the product. Do not use harsh chemicals such as gasoline, carbon tetrachloride, paint thinner, etc.

CAUTION

A qualified repair technician must perform any tool service or repair. Service or maintenance performed by unqualified personnel could result in injury. Use only identical replacement parts. Use of unauthorized parts or failure to follow maintenance instructions may create a risk of electric shock or injury.

⚠ WARNING

Do not make contact with a grounded surface while using this power tool. Contact with surfaces like pipes, radiators or major appliances increase your risk of electric shock.

Keep construction debris out of vents and power button by blowing with compressed air. If compressed air is unavailable, use a soft bristle shop brush.

Use only mild soap and a slightly damp cloth to clean the tool.

ACCESSORIES

Use only accessories that are recommended by the manufacturer for your model. Accessories that may be suitable for one tool may become hazardous when used on another tool.

Always attach grounded (3-prong) extension cords to grounded (3-prong) outlets.

If you must use an extension cord, be sure that the gauge is large enough to carry the amount of current necessary for your power tool. If not, your tool may experience a loss of power, excessive voltage drop or overheating. For example, the smaller the gauge number, the heavier the cord.

The Bench Grinder will accept most polishing and buffing wheels, sold separately.

PARTS DIAGRAM

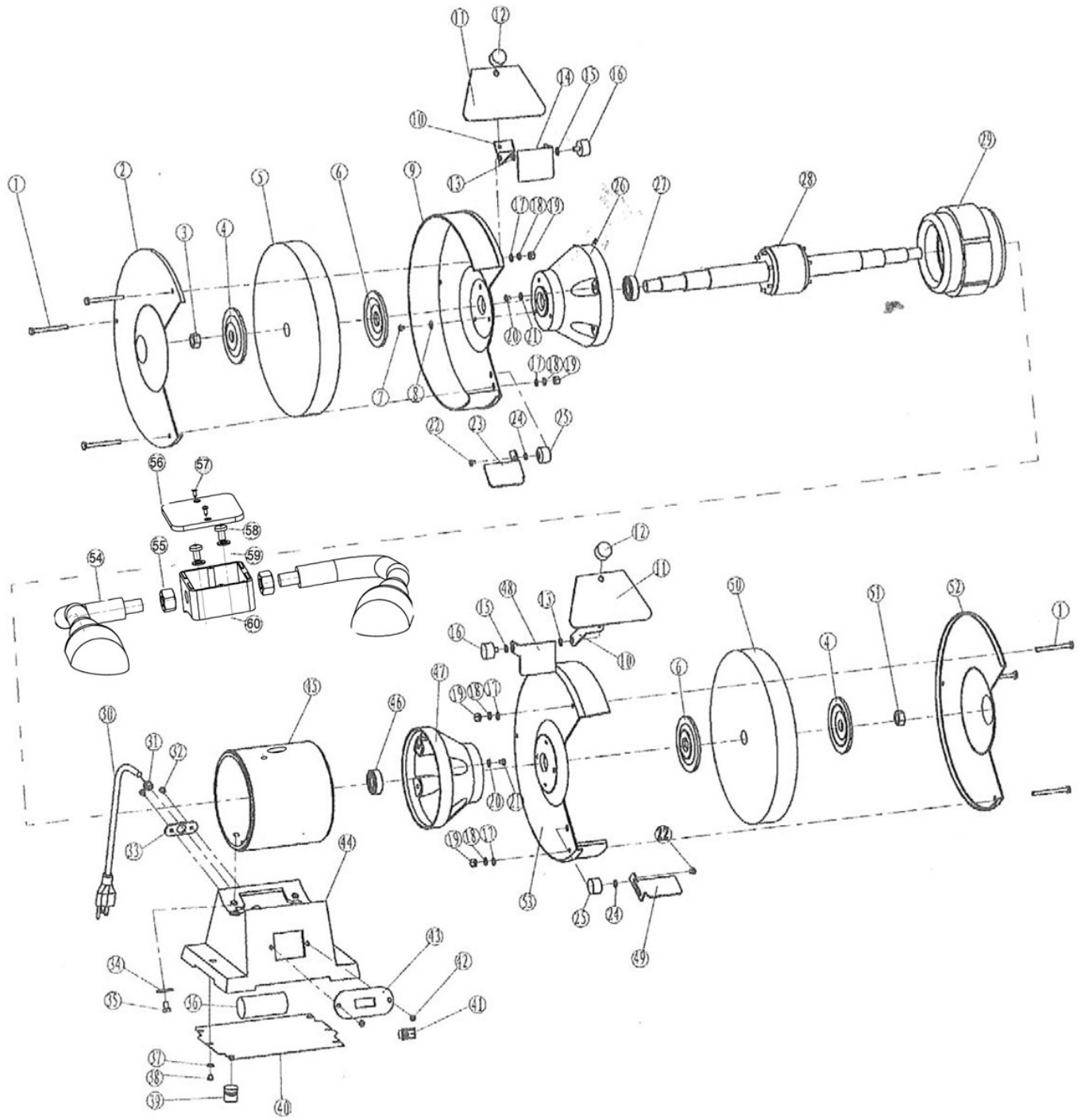

PARTS LIST

Part #	Description	Part #	Description
BG8DL-0001	Bolt	BG8DL-0028	Rotor
BG8DL-0002	Left Wheel Cover	BG8DL-0029	Stator
BG8DL-0003	Left Lock Nut	BG8DL-0030	Cord and plug
BG8DL-0004	Outer clamp washer	BG8DL-0031	Cord Bushing
BG8DL-0005	Wheel	BG8DL-0032	Screw
BG8DL-0006	Inner Clamp Washer	BG8DL-0033	Cord Bushing Plate
BG8DL-0007	Screw	BG8DL-0034	Washer
BG8DL-0008	Washer	BG8DL-0035	Screw
BG8DL-0009	Left Wheel Guard	BG8DL-0036	Capacitor
BG8DL-0010	Eye Shield Mount	BG8DL-0037	Washer
BG8DL-0011	Eye Shield	BG8DL-0038	Screw
BG8DL-0012	Knob	BG8DL-0039	Rubber foot
BG8DL-0013	Serrated Washer	BG8DL-0040	Base Plate
BG8DL-0014	Left Spark Guard	BG8DL-0041	Switch
BG8DL-0015	Washer	BG8DL-0042	Screw
BG8DL-0016	Knob	BG8DL-0043	Switch Plate
BG8DL-0017	Flat Washer	BG8DL-0044	Base
BG8DL-0018	Spring Washer	BG8DL-0045	Stator Housing
BG8DL-0019	Nut	BG8DL-0046	Bearing
BG8DL-0020	Screw	BG8DL-0047	End Bell
BG8DL-0021	Washer	BG8DL-0048	Right Spark Guard
BG8DL-0022	Screw	BG8DL-0049	Right Tool Rest
BG8DL-0023	Left tool rest	BG8DL-0050	Wheel
BG8DL-0024	Washer	BG8DL-0051	Right Lock Nut
BG8DL-0025	Tool Rest Knob	BG8DL-0052	Right Wheel Cover
BG8DL-0026	End Bell	BG8DL-0053	Right Wheel Guard
BG8DL-0027	Bearing	BG8DL-0054	Light
		BG8DL-0055	Nut
		BG8DL-0056	Light Fixing Box Cover
		BG8DL-0057	Screw
		BG8DL-0058	Screw
		BG8DL-0059	Washer
		BG8DL-0060	Light Fixing Box

NOTES: